

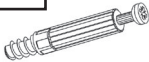











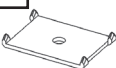
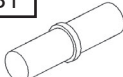

ANIMALS RW12

INSTRUKCJA MONTAŻU ASSEMBLY INSTRUCTIONS

Akcesoria / Fittings

K1  10 szt. / pcs	M2  10 szt. / pcs	M1  14 szt. / pcs	ZM1  14 szt. / pcs	ZW1  6 szt. / pcs	TZ1  1 szt. / pcs	G1  15 szt. / pcs
T1  6 szt. / pcs	B1  32 szt. / pcs	W4  Ø4 x 16 16 szt. / pcs	W6  Ø6,3 x 50 6 szt. / pcs	M3  2 szt. / pcs	K2  2 szt. / pcs	N1  4 szt. / pcs
W5  Ø4 x 35 1 szt. / pcs	Q1  1 szt. / pcs	Q2  1 szt. / pcs				

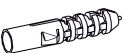
Narzędzia / Tools

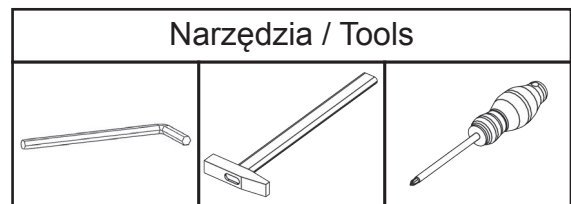

**DO MONTAŻU POTRZEBNE SĄ DWIE OSOBY!
INSTALLATION REQUIRES TWO PEOPLE!**

BARDZO WAŻNE!
NALEŻY UWAŻNIE PRZECZYTAĆ
ZACHOWAĆ DO PÓŹNIEJSZEGO STOSOWANIA

INSTRUKCJA OBSŁUGI

1.

By zapobiec zadławieniu lub uduszeniu opakowanie z akcesoriami należy trzymać w miejscu niedostępnym dla niemowląt i dzieci.

2.

Wszystkie połączenia w meblu muszą być dobrze dokręcone, żaden z elementów łączących nie może być luźny.

3.

Nie należy używać regału jeśli jakikolwiek element jest uszkodzony lub brakuje elementu.

4.

Należy używać tylko elementów dopuszczonych przez producenta.

5.

Nie należy w pobliżu regału umieszczać otwartych źródeł ognia oraz innych silnych źródeł ciepła, jak promienniki gazowe lub elektryczne itp., gdyż grozi to pożarem.

6.

Regał należy przytwierdzić do ściany za pomocą dołączonej taśmy zabezpieczającej!

VERY IMPORTANT!
PLEASE READ CAREFULLY
SAVE FOR FUTURE USE

USER'S MANUAL

1.

To avoid the danger of choking or strangulation keep the package with fittings away from babies and children.

2.

All connections must be tightened properly and no coupled element can not be loose.

3.

Do not use the bookstand when, if any of the elements is damaged or if there is any element missing.

4.

Use only the elements given by manufacturer.

5.

Do not place the bookstand near naked flames or other heat sources such as electric or gas radiators etc., this may cause a fire.

6.

The bookstand must be fixed to the wall using the supplied roll-over protection tape!

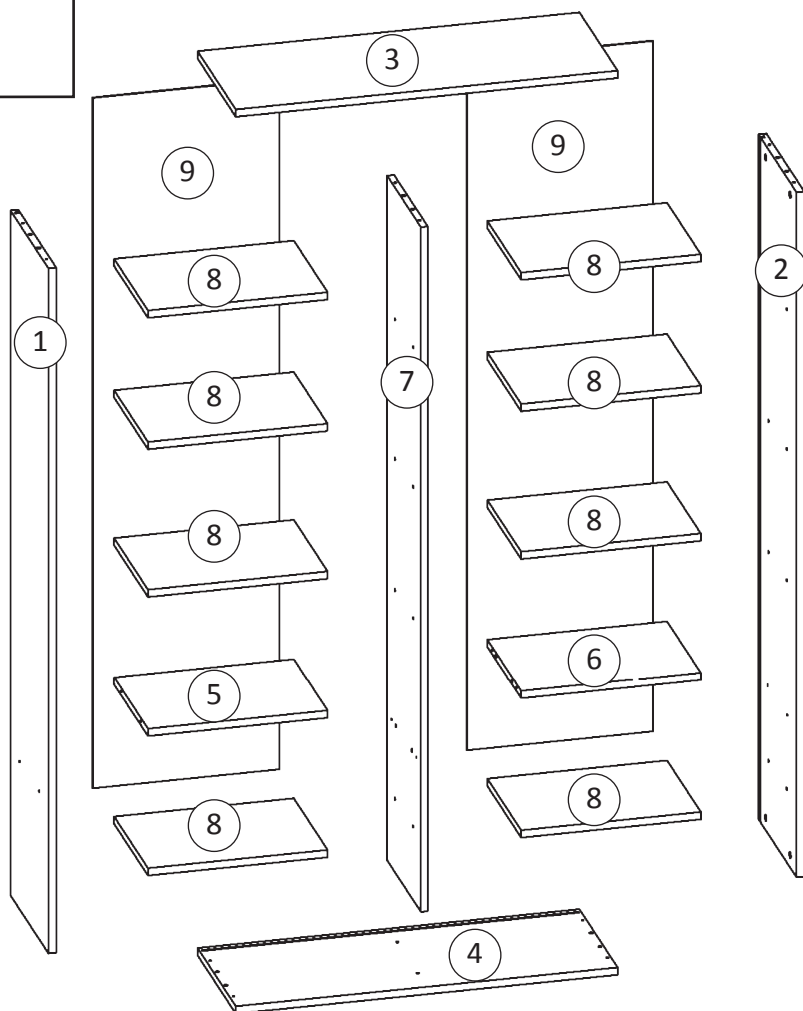

Paczka 1 z 1 / Package 1 of 1		
Numer elementu / item no.	Wymiary (mm)/ Dimensions (mm)	Ilość / Quantity
1	1672 x 340 x 18	1
2	1672 x 340 x 18	1
3	884 x 342 x 18	1
4	884 x 342 x 18	1
5	414 x 307 x 18	1
6	414 x 307 x 18	1
7	1672 x 307 x 18	1
8	414 x 297 x 18	8
9	1690 x 431 x 3	2

PRZED MONTAŻEM MEBLA NALEŻY DOKŁADNIE SPRAWDZIĆ CZY PACZKI ZAWIERAJĄ WSZYSTKIE ELEMENTY WYSZCZEGÓLNIONE W TABELCE NA STRONIE 3 ORAZ CZY ELEMENTY TE NIE SĄ USZKODZONE !!!
JEŚLI BRAKUJE ELEMENTÓW LUB NIEKTÓRE Z NICH SĄ USZKODZONE PROSIMY O KONTAKT Z NASZYM BIUREM
OBSŁUGI KLIENTA.

USZKODZENIA ELEMENTÓW STWIERDZONE JUŻ PO MONTAŻU MEBLA NIE BĘDĄ UWZGLĘDNIANE !!!

BEFORE ASSEMBLING THE FURNITURE PLEASE CHECK THAT PACKAGES INCLUDE ALL ITEMS LISTED IN THE TABLE ON PAGE NO 3, AND WHETHER THESE ITEMS ARE NOT DAMAGED !!!
IF MISSING PARTS OR SOME OF THEM ARE DAMAGED, PLEASE CONTACT OUR CUSTOMER SERVICE OFFICE.
DAMAGES FOUND AFTER ASSEMBLING WILL NOT BE CONSIDERED !!!

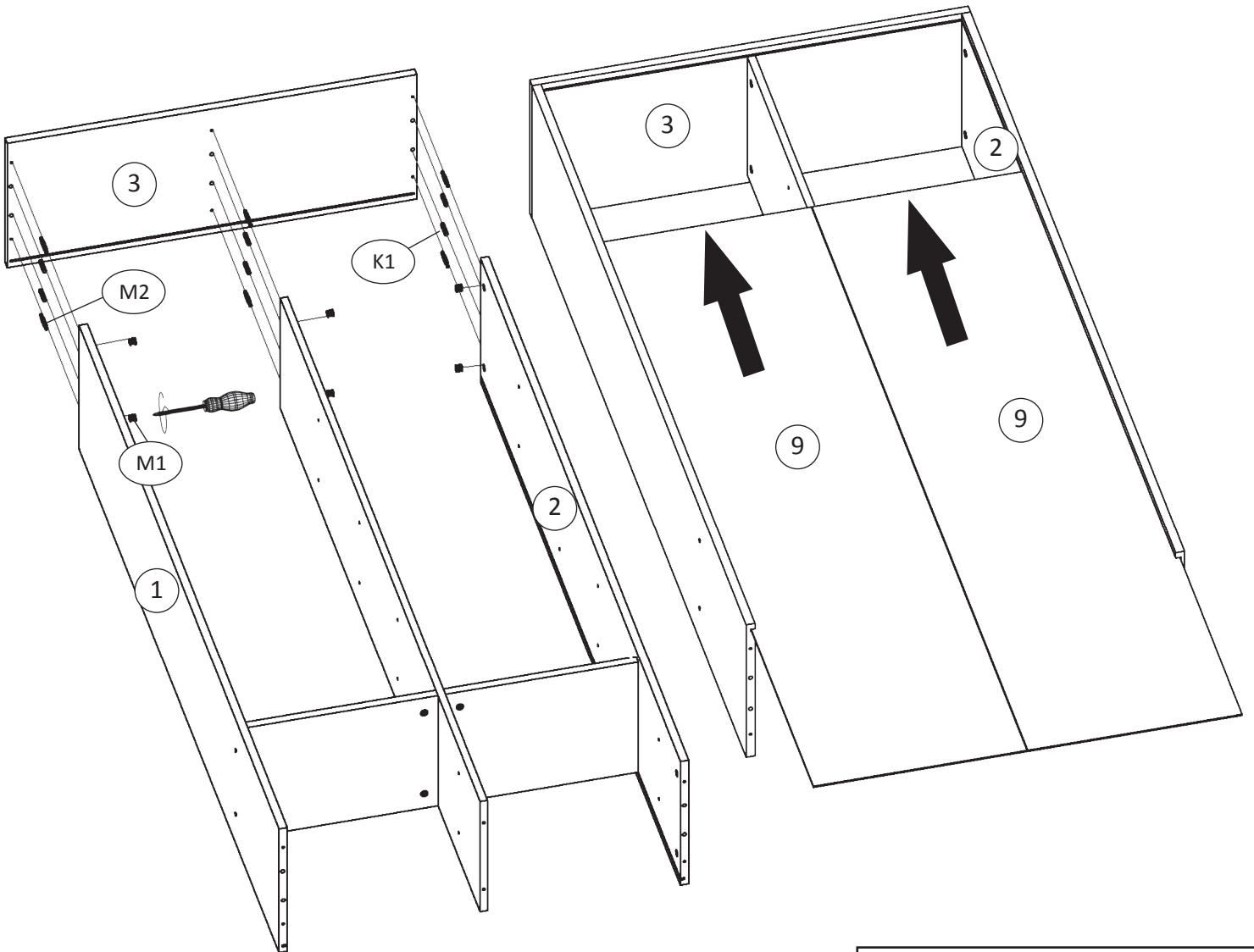
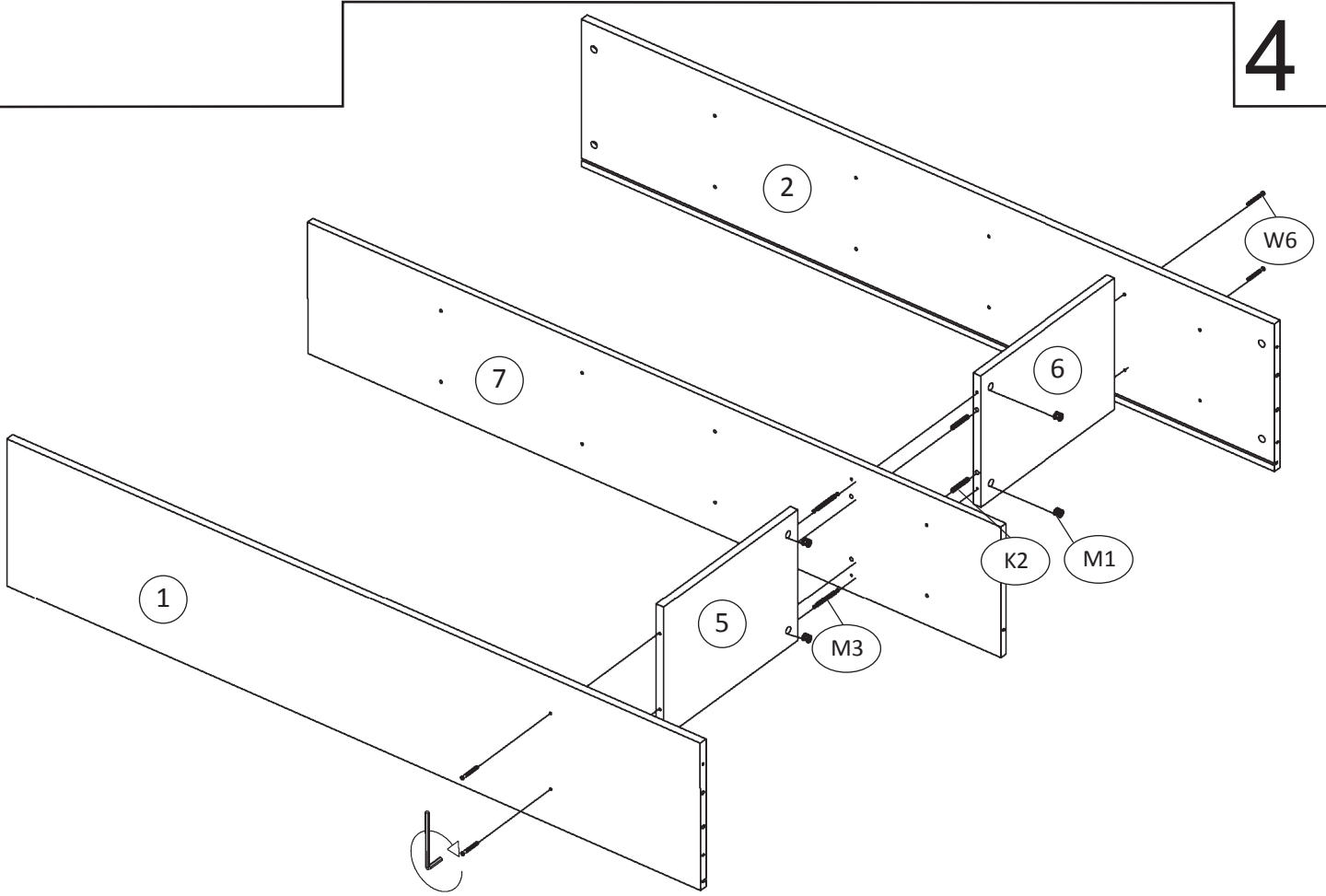

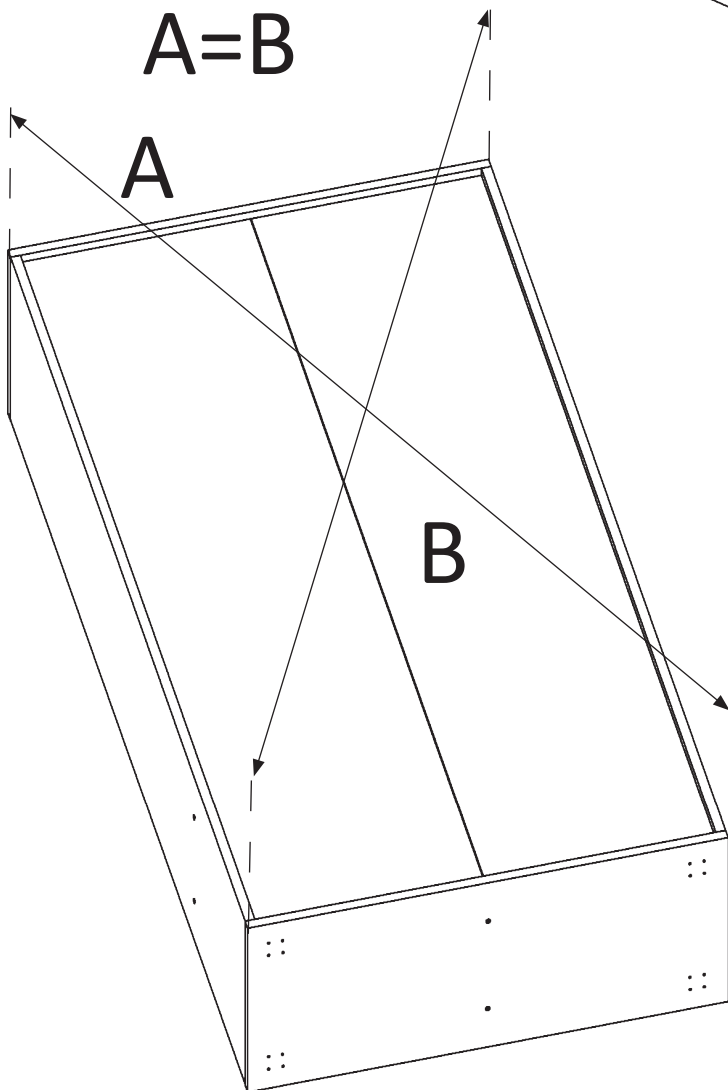
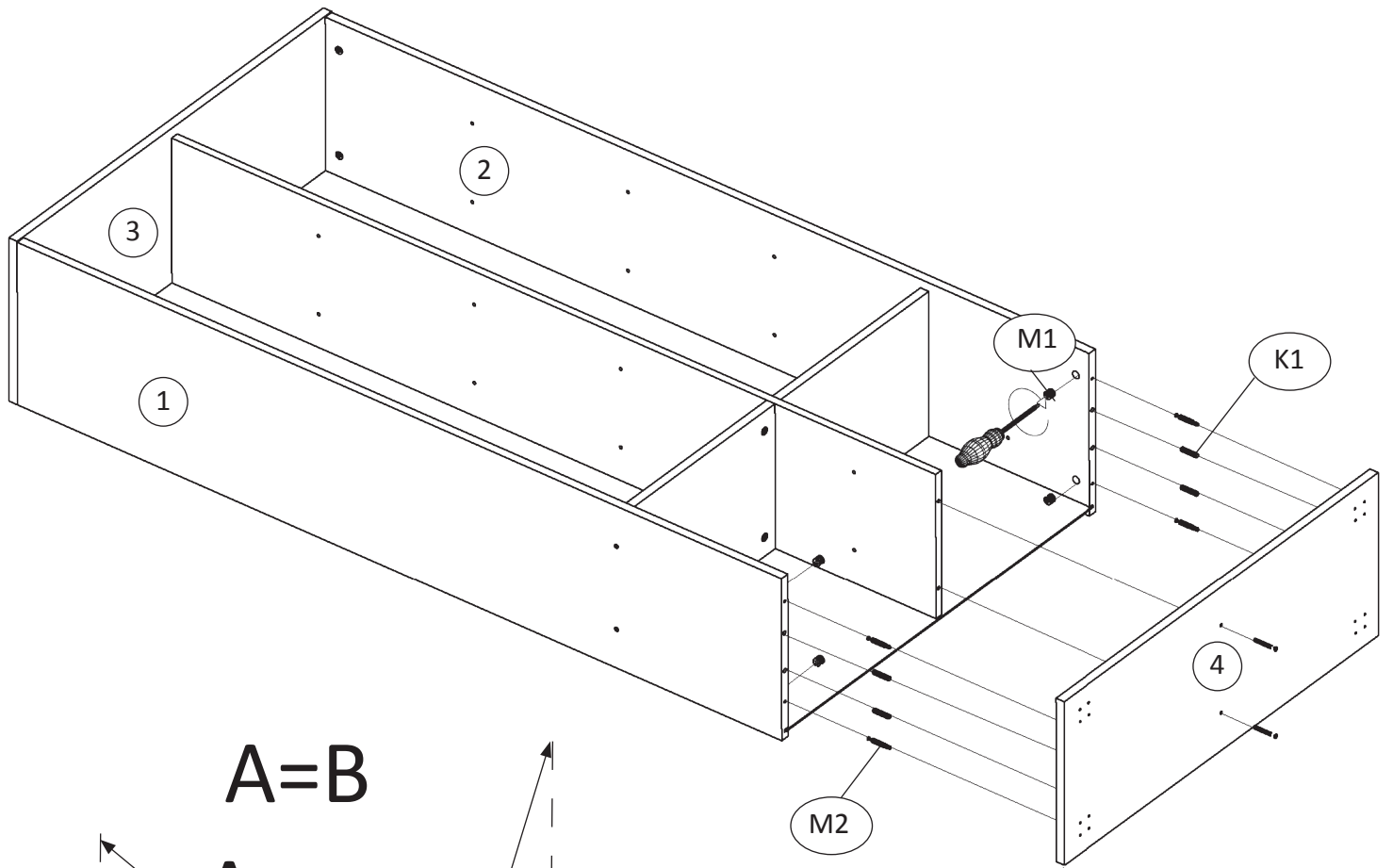

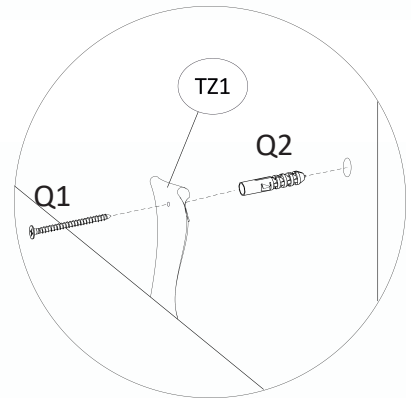
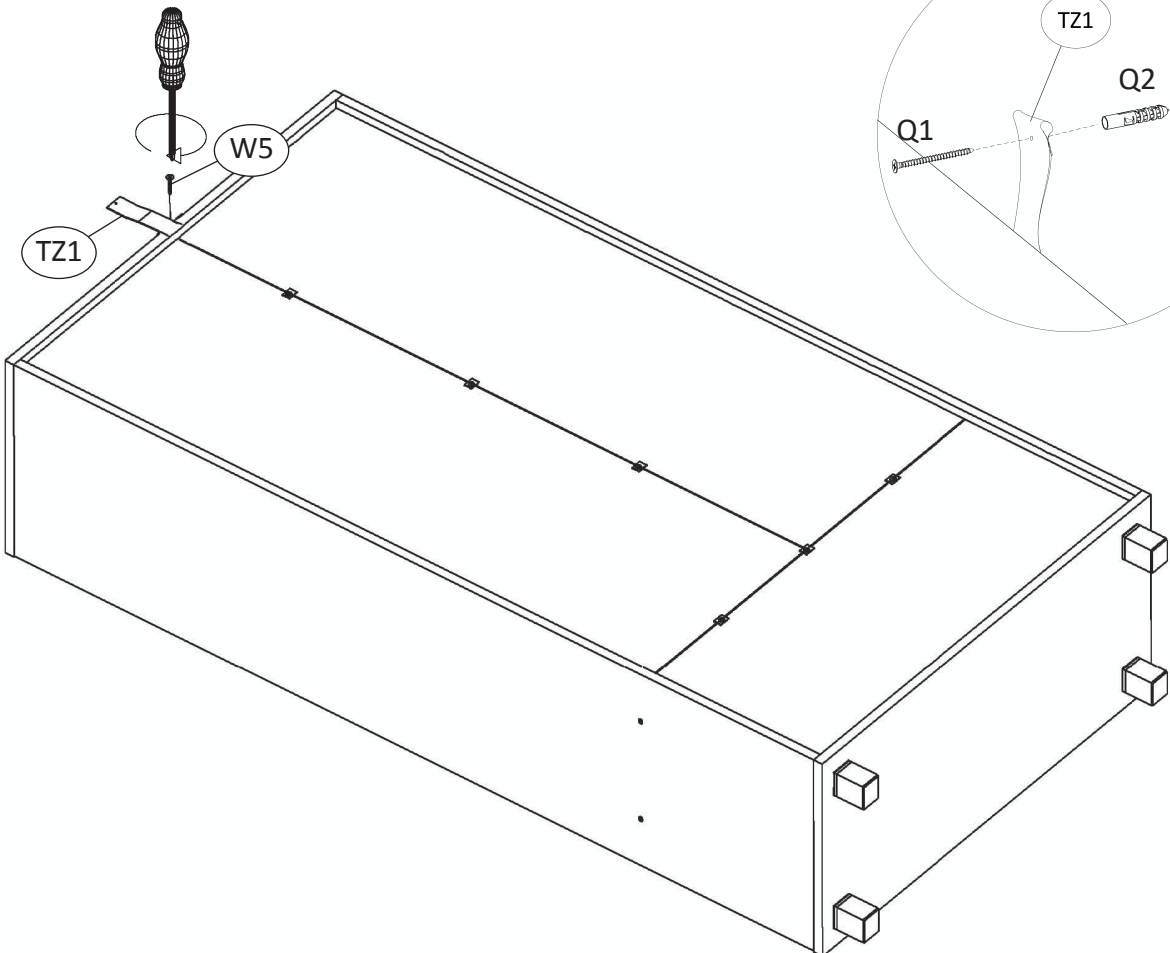
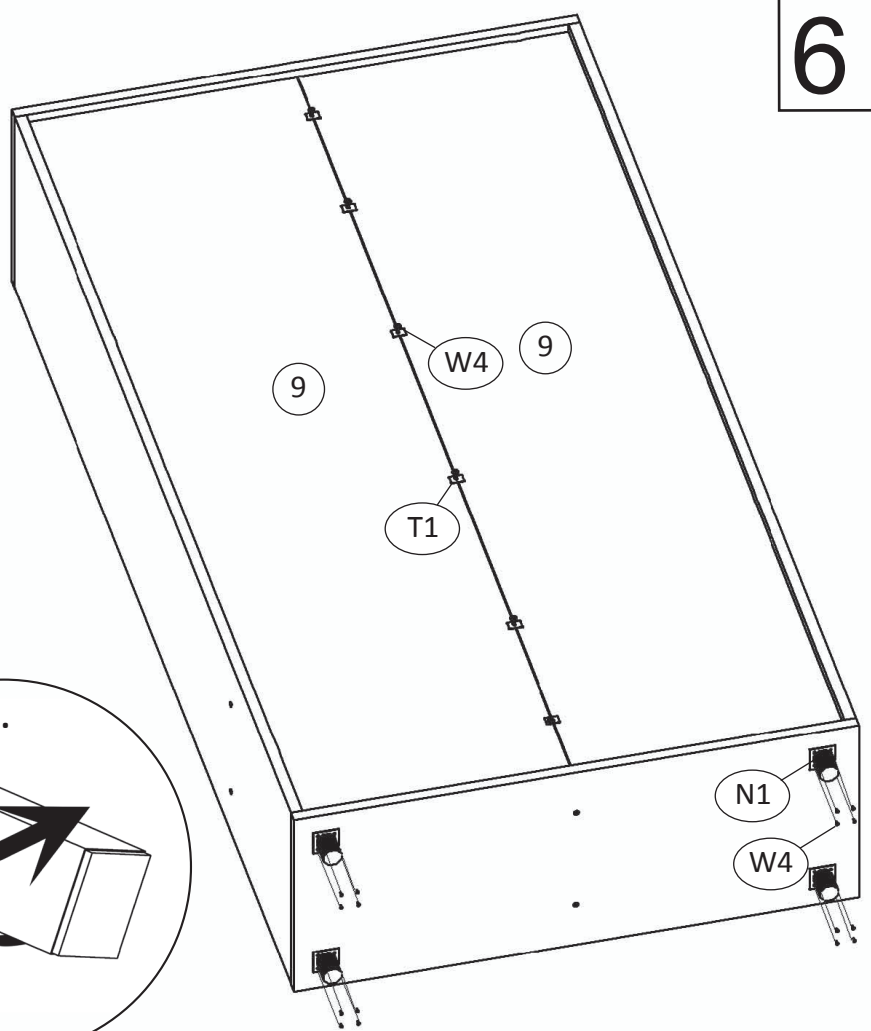
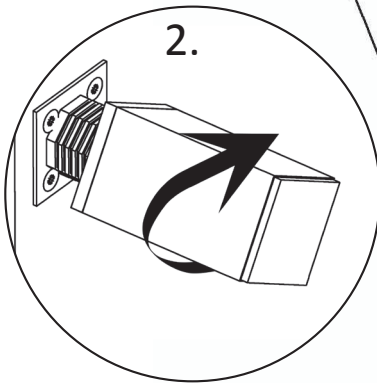
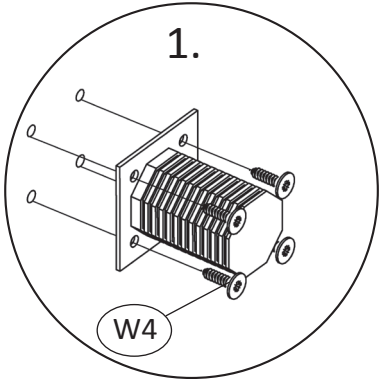
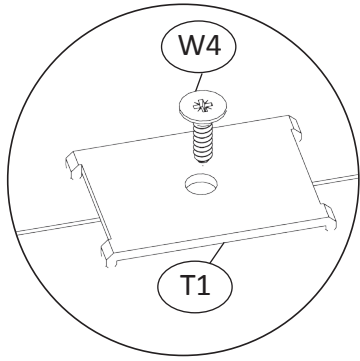

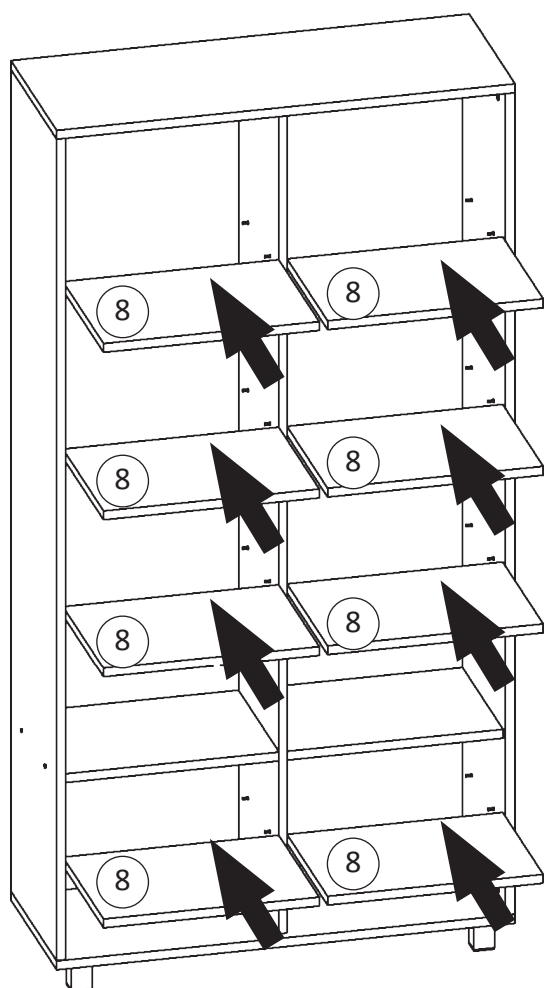
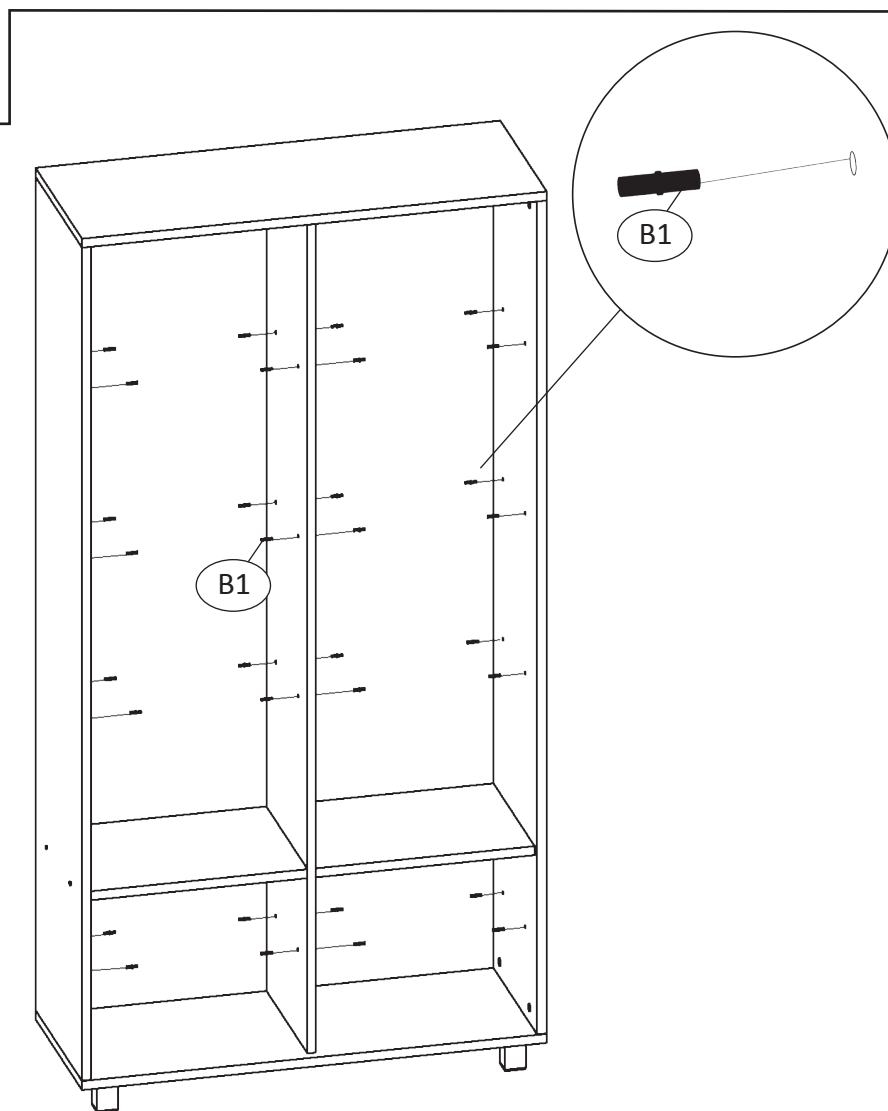

Na widocznych śrubach (W6) należy umieścić dostarczone zaślepki samoprzylepne (ZW1).

On the visible screws (W6) should be placed supplied adhesive caps (ZW1).

Na mimośrodkach (M1) należy umieścić dostarczone plastikowe zaślepki (ZM1).

On the eccentrics (M1) should be placed supplied plastic caps (ZM1).